



Linear Bushing

THK General Catalog

A Technical Descriptions of the Products

Features and Types	A-524
Features of the Linear Bushing	A-524
• Structure and features.....	A-524
• Dedicated Shafts for Model LM.....	A-526
• Standard LM Shafts	A-526
• Specially Machined Types	A-526
• Table of Rows of Balls and Masses for Clearance-adjustable Types and Open Types of the Linear Bushing	A-527
Types of the Linear Bushing	A-528
• Types and Features.....	A-528
Classification Table	A-534
Point of Selection	A-536
Flowchart for Selecting a Linear Bushing ...	A-536
• Steps for Selecting a Linear Bushing ...	A-536
Rated Load and Nominal Life.....	A-537
Table of Equivalent Factors	A-540
Accuracy Standards	A-541
Point of Design	A-542
Assembling the Linear Bushing.....	A-542
Options	A-549
Lubrication.....	A-549
Material, surface treatment	A-549
Contamination Protection.....	A-550
• Felt Seal Model FLM.....	A-550
Precautions on Use	A-551

B Product Specifications (Separate)

Dimensional Drawing, Dimensional Table ..	B-417
Model LM	B-418
Model LM-GA (Metal Retainer Type) ...	B-420
Model LM-MG (Stainless Steel Type) ..	B-422
Model LME	B-424
Model LM-L	B-426
Model LMF	B-428
Model LMF-M (Stainless Steel Type)...	B-430
Model LMK	B-432
Model LMK-M (Stainless Steel Type)...	B-434
Model LMF-L	B-436
Model LMF-ML (Stainless Steel Type) ..	B-438
Model LMK-L	B-440
Model LMK-ML (stainless steel type) ...	B-442
Model LMH	B-444
Model LMH-L	B-446
Models SC6 to 30	B-448
Models SC35 to 50.....	B-450
Model SL	B-452
Model SH	B-454
Model SH-L	B-456
Model SK.....	B-458
Dedicated Shafts for Model LM.....	B-459
Standard LM Shafts	B-460
Options	B-461
Felt Seal Model FLM	B-461

* Please see the separate "B Product Specifications".

Features of the Linear Bushing

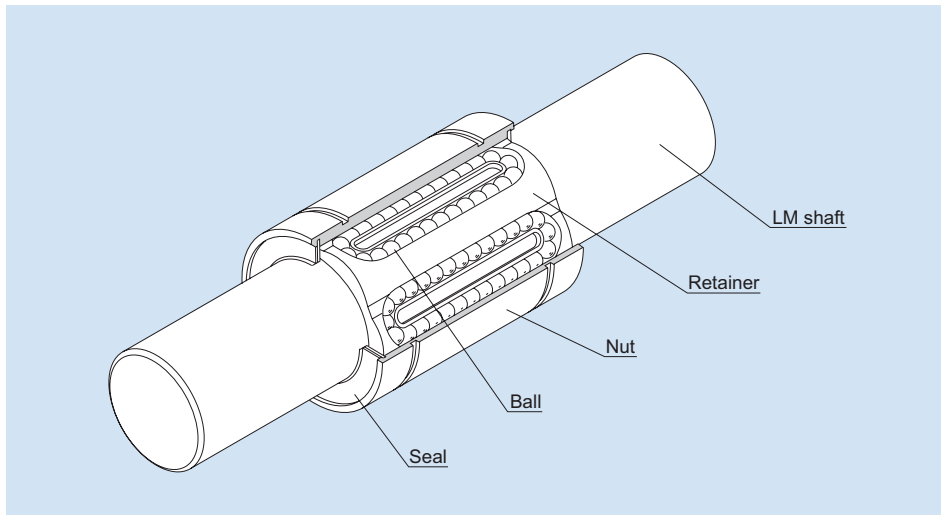

Fig.1 Structure of Linear Bushing Model LM···UU

Structure and Features

Linear Bushing model LM is a linear motion system used in combination with a cylindrical LM shaft to perform infinite straight motion. The balls in the loaded area of the nut are in point contact with the LM shaft. This allows straight motion with minimal friction resistance and achieves highly accurate and smooth motion despite the small permissible load.

The nut uses high-carbon chromium bearing steel and its outer and inner surfaces are ground after being heat-treated.

The Linear Bushing is used in a broad array of applications, such as slide units of precision equipment including OA equipment and peripherals, measuring instruments, automatic recorders and digital 3D measuring instruments, industrial machines including multi-spindle drilling machine, punching press, tool grinder, automatic gas cutting apparatus, printing machine, card selector and food packing machine.

Features and Types

Features of the Linear Bushing

[Interchangeability]

Since the dimensional tolerances of the Linear Bush's components are standardized, they are interchangeable. The LM shaft is machined through cylindrical grinding, which can easily be performed, and it allows highly accurate fitting clearance to be achieved.

[Highly Accurate Retainer Plate]

Since the retainer, which guides three to eight rows of balls, is integrally molded, it is capable of accurately guiding the balls in the traveling direction and achieving stable running accuracy. Small-diameter types use integrally molded retainers made of synthetic resin. It reduces noise generated during operation and allows for superb lubrication.

[Wide Array of Types]

A wide array of types are available, such as standard type, clearance-adjustable type, open type, long type and flanged linear bushing, allowing the user to select a type that meets the intended use.

Dedicated Shafts for Model LM

The LM shaft of the Linear Bushing needs to be manufactured with much consideration for hardness, surface roughness and dimensional accuracy of the shaft since balls roll directly on it. THK manufactures dedicated LM shafts for the Linear Bushing.

Standard LM Shafts

THK manufactures high quality, dedicated LM shafts for Linear Bushing model LM series.

Specially Machined Types

THK also supports special machining processes such as tapping, milling, threading, through hole and joggling, as shown in the Fig.2, at your request.

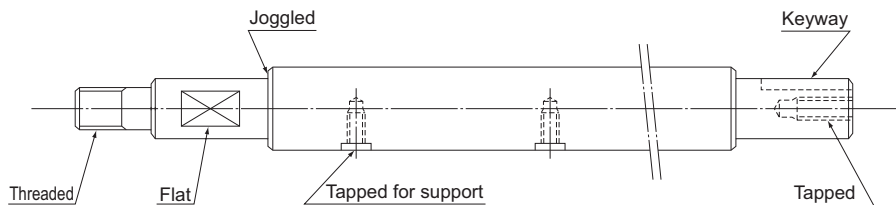

Fig.2

**Table of Rows of Balls and Masses for Clearance-adjustable Types
and Open Types of the Linear Bushing**

Shaft diameter	Clearance-adjustable type			Open type		
	Model No.	Rows of balls	Mass g	Model No.	Rows of balls	Mass g
6	LM 6-AJ	4	7.8	—	—	—
8	LM 8S-AJ	4	10	—	—	—
	LM 8-AJ	4	14.7	—	—	—
10	LM 10-AJ	4	29	—	—	—
12	LM 12-AJ	4	31	LM 12-OP	3	25
13	LM 13-AJ	4	42	LM 13-OP	3	34
16	LM 16-AJ	5(4)	68	LM 16-OP	4(3)	52
20	LM 20-AJ	5	85	LM 20-OP	4	69
25	LM 25-AJ	6(5)	216	LM 25-OP	5(4)	188
30	LM 30-AJ	6	245	LM 30-OP	5	210
35	LM 35-AJ	6	384	LM 35-OP	5	350
38	LM 38-AJ	6	475	LM 38-OP	5	400
40	LM 40-AJ	6	579	LM 40-OP	5	500
50	LM 50-AJ	6	1560	LM 50-OP	5	1340
60	LM 60-AJ	6	1820	LM 60-OP	5	1650
80	LM 80-AJ	6	4320	LM 80-OP	5	3750
100	LM 100-AJ	6	8540	LM 100-OP	5	7200
120	LM 120-AJ	8	14900	LM 120-OP	6	11600

Note) The numbers of ball rows in the table apply to types using a resin retainer. Those of types using a metal retainer are indicated in parentheses.

Linear Bushing Types

Types and Features

Standard Type

With the Linear Bushing nut having the most accurate cylindrical shape, this type is widely used.

There are two series of the Linear Bushing in dimensional group.

- Model LM
Metric units series used most widely in Japan
- Model LM-MG
Stainless steel version of type LM
- Model LME
Metric units series commonly used in Europe

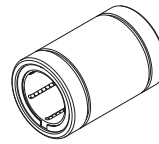

Standard Type

Open Type

The nut is partially cut open by one row of balls (50° to 80°). This enables the Linear Bushing to be used even in locations where the LM shaft is supported by a column or fulcrum. In addition, a clearance can easily be adjusted.

Models LM-OP/LME-OP
Model LM-MG-OP

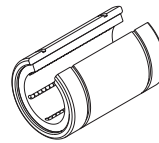

Open Type

Clearance-adjustable Type

This type has the same dimensions as the standard type, but the nut has a slit in the direction of the LM shaft. This allows the linear bushing to be installed in a housing whose inner diameter is adjustable, and enables the clearance between the LM shaft and the housing to easily be adjusted.

Models LM-AJ/LME-AJ
Model LM-MG-AJ

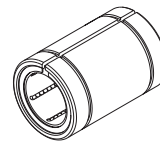

Clearance-adjustable Type

Long Type

Containing two units of the standard retainer plate, this type is optimal for locations where a moment load is present and reduces man-hours in installation.

Model LM-L·····Standard type

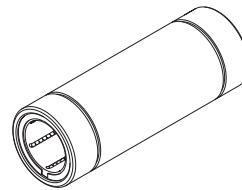

Long Type

Flanged Type (Round)

The nut of the standard type Linear Bushing is integrated with a flange. This enables the Linear Bushing to be directly mounted onto the housing with bolts, thus achieving easy installation.

Model LMF·····Standard type
Model LMF-M·····Made of stainless steel

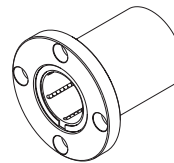

Flanged Type (Round)

Flanged Type (Square)

Like model LMF, this type also has a flange, but the flange is cut to a square shape. Since the height is lower than the circular flange type, compact design is allowed.

Model LMK······Standard type

Model LMK-M······Made of stainless steel

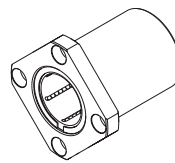

Flanged Type (Square)

Flanged Type (Round) - Long

The nut of the long type Linear Bushing is integrated with a flange. This enables the Linear Bushing to be directly mounted onto the housing with bolts, thus achieving easy installation. Containing two units of the standard retainer plate, this type is optimal for locations where a moment load is present.

Model LMF-L······Standard type

Model LMF-ML······Made of stainless steel

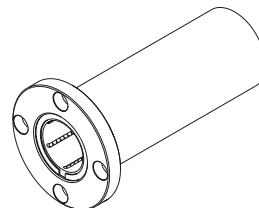

Flanged Type (Round) - Long

Flanged Type (Square) - Long

Like model LMF-L, this type also has a flange, but the flange is cut to a square shape. Since the height is lower than the circular flange type, compact design is allowed.

Model LMK-L······Standard type

Model LMK-ML······Made of stainless steel

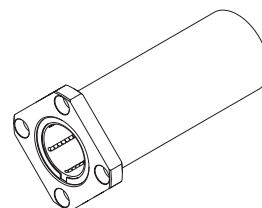

Flanged Type (Square) - Long

Flanged Type (Cut Flange)

The nut is integrated with a cut flange. Since the height is lower than model LMK, compact design is allowed. Since the rows of balls in the Linear Bushing are arranged so that two rows receive the load from the flat side, a long service life can be achieved.

Model LMH······Standard type

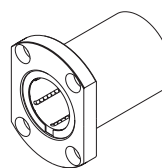

Flanged Type (Cut Flange)

Flanged Type (Cut Flange) - Long

The flange is a cut flange and lower than model LMK-L, allowing compact design. Containing two units of the standard retainer plate, this type is optimal for locations where a moment load is present. Since the rows of balls in the Linear Bushing are arranged so that two rows receive the load from the flat side, a long service life can be achieved.

Model LMH-L······Standard type

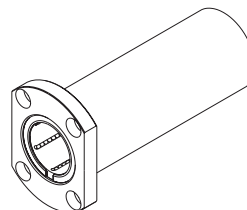

Flanged Type (Cut Flange) - Long

Linear Bushing Model SC

It is a case unit where the standard type of Linear Bushing is incorporated into a small, light-weight aluminum casing. This model can easily be mounted simply by securing it to the table with bolts.

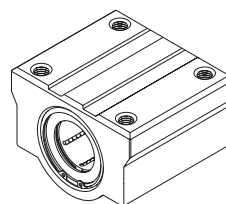

Linear Bushing Model SC

Linear Bushing (Long) Model SL

A long version of model SC, this model contains two units of the standard type Linear Bushing in an aluminum casing.

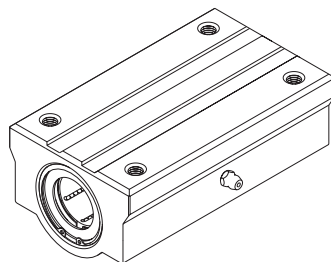

Linear Bushing (Long) Model SL

Linear Bushing Model SH

It is a case unit where the standard type of Linear Bushing is incorporated into a smaller and lighter aluminum casing than model SC. This model allows even more compact design than model SC. It also has flexibility in mounting orientation. Additionally, it is structured so that two rows of balls receive the load from the top of the casing, allowing a long service life to be achieved.

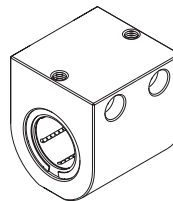

Linear Bushing Model SH

Linear Bushing (Long) Model SH-L

A long version of model SH, this model is a case unit that contains two units of the standard type Linear Bushing in an aluminum casing.

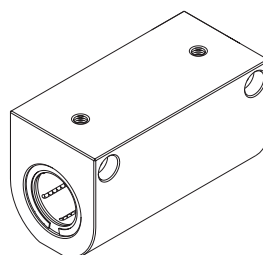

Linear Bushing (Long) Model SH-L

LM Shaft End Support Model SK

An aluminum-made light fulcrum for securing an LM shaft. The LM shaft mounting section has a slit, enabling the linear bushing to firmly secure an LM shaft using bolts.

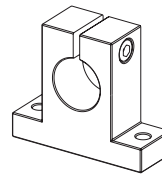

LM Shaft End Support Model SK

Standard LM Shafts

THK manufactures high quality, dedicated LM shafts for Linear Bushing model LM series.



Standard LM Shafts

Build-to-order LM Shafts

THK also manufactures hollow LM shafts and specially machined shafts at your request.



Build-to-order LM Shafts

Linear Bushing

Classification Table

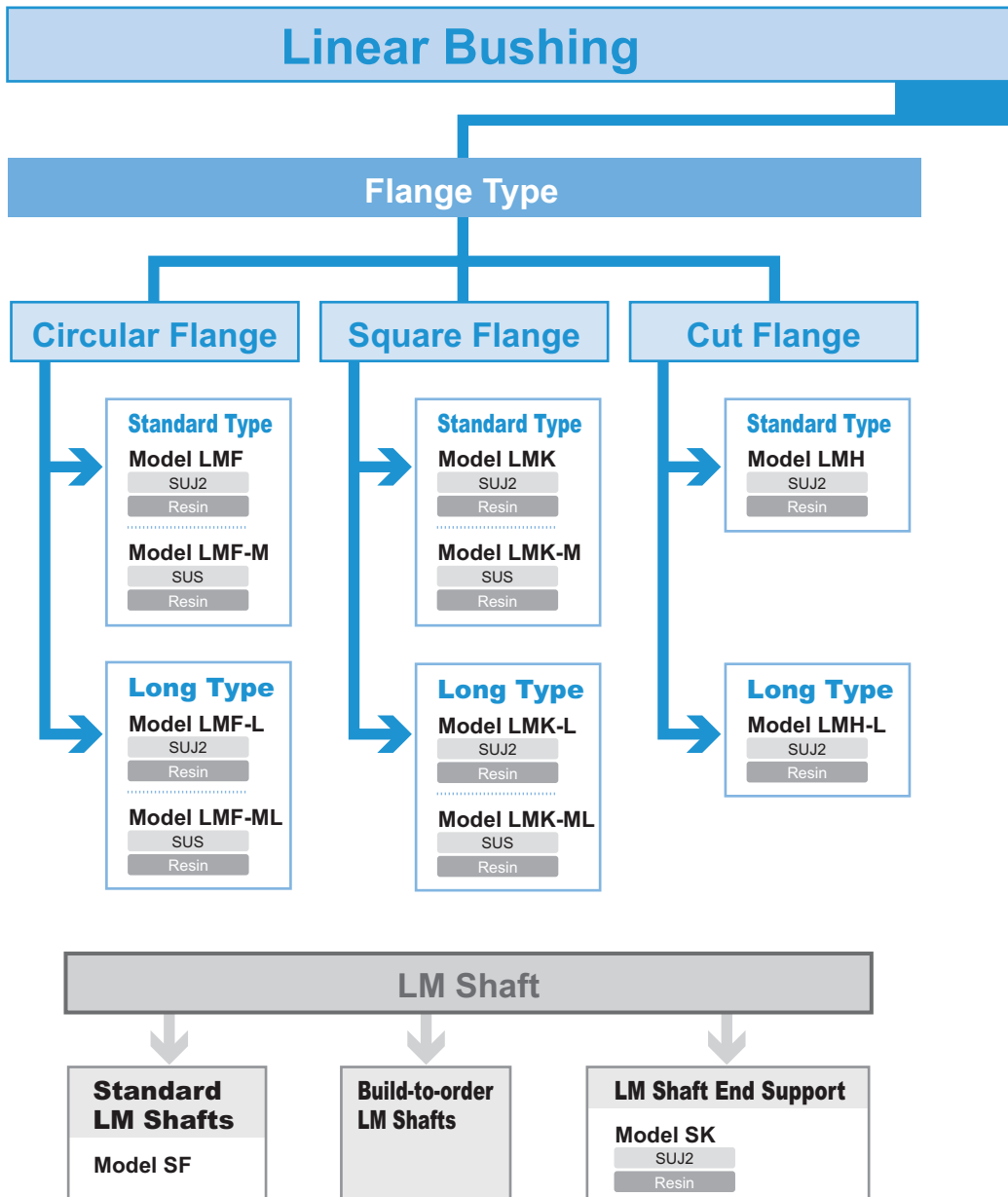

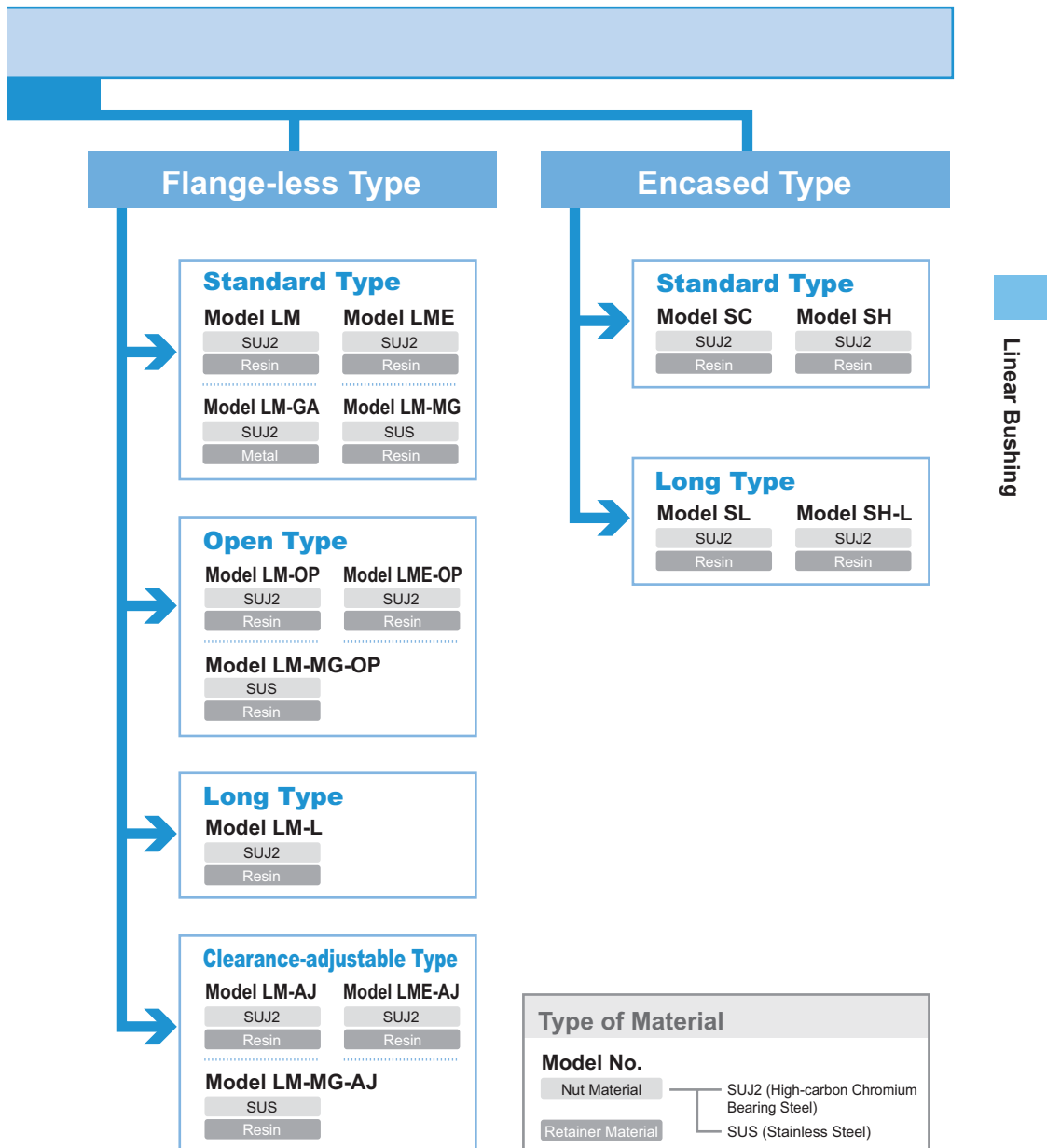

Flowchart for Selecting a Linear Bushing

Steps for Selecting a Linear Bushing

The following flowchart should be used as a guide for selecting a Linear Bushing.

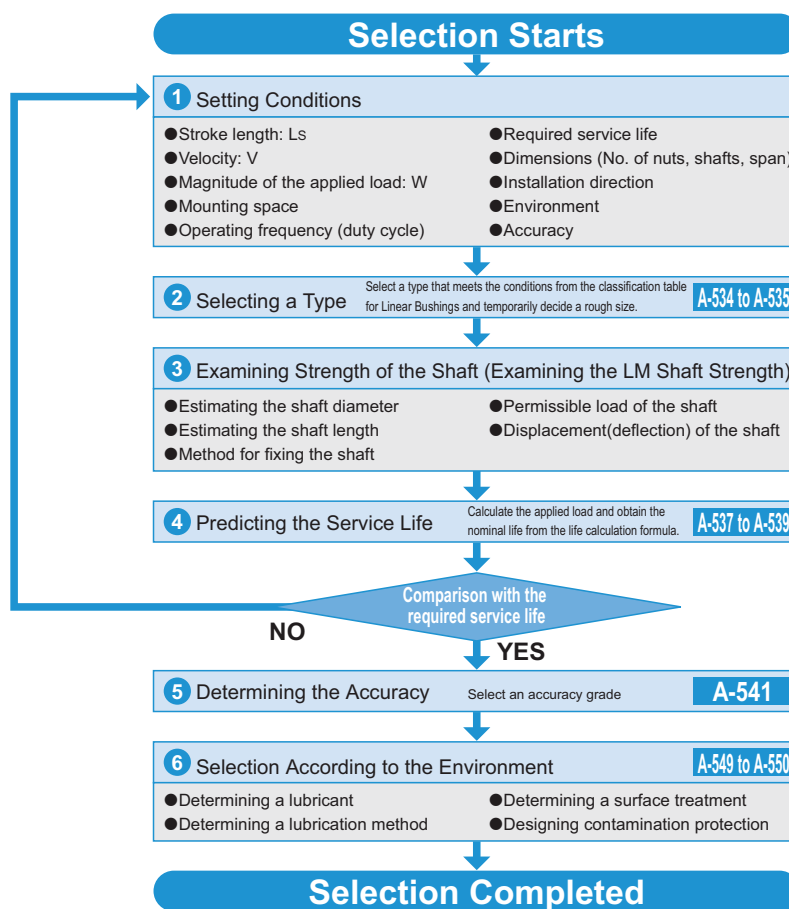

Rated Load and Nominal Life

[Load Rating]

The rated load of the Linear Bushing varies according to the position of balls in relation to the load direction. The basic load ratings indicated in the specification tables each indicate the value when one row of balls receiving a load are directly under the load.

If the Linear Bushing is mounted so that two rows of balls evenly receive the load in the load direction, the rated load changes as shown in table 1.

Table1

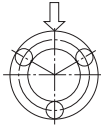
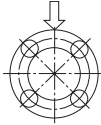
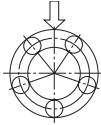
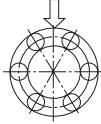
Rows of balls	Ball position	Load Rating
3 rows		$1 \times C$
4 rows		$1.41 \times C$
5 rows		$1.46 \times C$
6 rows		$1.28 \times C$

Linear Bushing

For specific values for "C" above, see the respective specification table.

[Calculating the Nominal Life]

The nominal life of the Linear Bushing is obtained using the following equation.

$$L = \left(\frac{f_H \cdot f_r \cdot f_c}{f_w} \cdot \frac{C}{P_c} \right)^3 \times 50$$

- L : Nominal life (km)
- C : Basic dynamic load rating (N)
- P_c : Calculated load (N)
- f_r : Temperature factor (see Fig.2 on A-539)
- f_c : Contact factor (see Table2 on A-539)
- f_w : Load factor (see Table3 on A-539)
- f_H : Hardness factor (see Fig.1)

● When a Moment Load is Applied to a Single Nut or Two Nuts in Close Contact with Each Other

When a moment load is applied to a single nut or two nuts in close contact with each other, calculate the equivalent radial load at the time the moment is applied.

P_u = K · M

- P_u : Equivalent radial load (N)
(with a moment applied)
- K : Equivalent factors
(see Table4 to Table6 on A-540)
- M : Applied moment (N-mm)

However, "P_u" is assumed to be within the basic static load rating (C₀).

● When a Moment Load and a Radial Load are Simultaneously Applied

When a moment and a radial load are applied simultaneously, calculate the service life based on the sum of the radial load and the equivalent radial load.

■ f_H: Hardness Factor

To maximize the load capacity of the Linear Bushing, the hardness of the raceways needs to be between 58 to 64 HRC.

If the hardness is lower than this range, the basic dynamic load rating and the basic static load rating decrease. Therefore, it is necessary to multiply each rating by the respective hardness factor (f_H).

Normally, f_H=1.0 since the Linear Bushing has sufficient hardness.

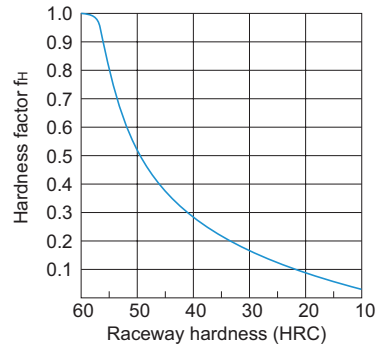

Fig.1 Hardness Factor (f_H)

Point of Selection
Rated Load and Nominal Life

■f_t: Temperature Factor

If the temperature of the environment surrounding the operating Linear Bushing exceeds 100°C, take into account the adverse effect of the high temperature and multiply the basic load ratings by the temperature factor indicated in Fig.2.

Also note that the Linear Bushing itself must be of high temperature type.

Note) If the environment temperature exceeds 80 °C, use a Linear Bushing type equipped with metal retainer plates.

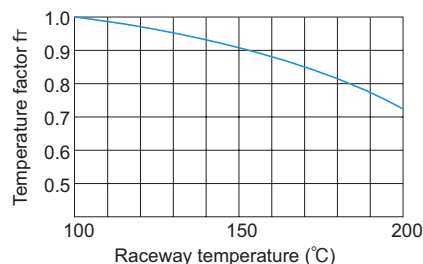

Fig.2 Temperature Factor (f_t)

■f_c: Contact Factor

When multiple nuts are used in close contact with each other, their linear motion is affected by moments and mounting accuracy, making it difficult to achieve uniform load distribution. In such applications, multiply the basic load rating (C) and (C₀) by the corresponding contact factor in Table2.

Note) If uneven load distribution is expected in a large machine, take into account the respective contact factor indicated in Table2.

Table2 Contact Factor (f_c)

Number of nuts in close contact with each other	Contact factor f _c
2	0.81
3	0.72
4	0.66
5	0.61
Normal use	1

■f_w: Load Factor

In general, reciprocating machines tend to involve vibrations or impact during operation. It is difficult to accurately determine vibrations generated during high-speed operation and impact during frequent start and stop motion. Therefore, when loads applied on a Linear Bushing cannot be measured, or when speed and impact have a significant influence, divide the basic load rating (C or C₀), by the corresponding load factor in Table3.

Table3 Load Factor (f_w)

Vibrations/impact	Speed(V)	f _w
Faint	Very low V ≤ 0.25m/s	1 to 1.2
Weak	Slow 0.25 < V ≤ 1m/s	1.2 to 1.5
Medium	Medium 1 < V ≤ 2m/s	1.5 to 2
Strong	High V > 2m/s	2 to 3.5

[Calculating the Service Life Time]

When the nominal life (L) has been obtained, if the stroke length and the number of reciprocations per minute are constant, the service life time is obtained using the following equation.

$$L_h = \frac{L \times 10^3}{2 \times l_s \times n_1 \times 60}$$

- L_h : Service life time (h)
- l_s : Stroke length (m)
- n₁ : Number of reciprocations per minute (min⁻¹)

Linear Bushing

Table of Equivalent Factors

Table4 Equivalent Factors of Model LM

Model No.	Equivalent factor: K	
	Single nut	Double blocks
LM 3	1.566	0.26
LM 4	1.566	0.21
LM 5	1.253	0.178
LM 6	0.553	0.162
LM 8S	0.708	0.166
LM 8	0.442	0.128
LM 10	0.389	0.101
LM 12	0.389	0.097
LM 13	0.343	0.093
LM 16	0.279	0.084
LM 20	0.257	0.071
LM 25	0.163	0.054
LM 30	0.153	0.049
LM 35	0.143	0.045
LM 38	0.127	0.042
LM 40	0.117	0.04
LM 50	0.096	0.032
LM 60	0.093	0.028
LM 80	0.077	0.022
LM 100	0.065	0.017
LM 120	0.051	0.015

Note) Equivalent factors for models LMF, LMK, LMH and SC are the same as that for model LM.

Table5 Equivalent Factors of Model LM-L

Model No.	Equivalent factor: K
	Single nut
LM 3L	0.654
LM 4L	0.578
LM 5L	0.446
LM 6L	0.402
LM 8L	0.302
LM 10L	0.236
LM 12L	0.226
LM 13L	0.214
LM 16L	0.192
LM 20L	0.164
LM 25L	0.12
LM 30L	0.106
LM 35L	0.1
LM 40L	0.086
LM 50L	0.068
LM 60L	0.062

Note) Equivalent factors for models LMF-L, LMK-L and LMH-L are the same as that for model LM-L.

Table6 Equivalent Factors of Model LME

Model No.	Equivalent factor: K	
	Single nut	Double blocks
LME 5	0.669	0.123
LME 8	0.514	0.116
LME 12	0.389	0.09
LME 16	0.343	0.081
LME 20	0.291	0.063
LME 25	0.209	0.052
LME 30	0.167	0.045
LME 40	0.127	0.039
LME 50	0.105	0.031
LME 60	0.093	0.024
LME 80	0.077	0.018

Accuracy Standards

The accuracy of the Linear Bushing in inscribed bore diameter, outer diameter, width and eccentricity is described in the corresponding specification table. The accuracy of mode LM in inscribed bore diameter and eccentricity is classified into high accuracy grade (no symbol) and precision grade (P). (Accuracy symbol is expressed at the end of the model number.)

The accuracy of clearance-adjustable types (-AJ) and open types (-OP) in inscribed bore diameter and outer diameter indicates the value before division.



Assembling the Linear Bushing

[Inner Diameter of the Housing]

Table1 shows recommended housing inner-diameter tolerance for the Linear Bushing. When fitting the Linear Bushing with the housing, loose fit is normally recommended. If the clearance needs to be smaller, provide transition fit.

Table1 Housing Inner-diameter Tolerance

Type		Housing	
Model No.	Accuracy	Loose fit	Transition fit
LM	High accuracy grade (no symbol)	H7	J7
	Precision Grade (P)	H6	J6
LME	—	H7	K6, J6
LMF	High accuracy grade (no symbol)	H7	J7
LMK			
LMH			
LM-L			
LMF-L			
LMK-L			
LMH-L			

[Clearance between the Nut and the LM Shaft]

When using the Linear Bushing in combination with an LM shaft, use normal clearance in ordinary use and small gap if the clearance is to be minimized.

Note1) If the clearance after installation is to be negative, it is preferable not to exceed the radial clearance tolerance indicated in the specification table.

Note2) The shaft tolerance for Linear Bushing models SC, SL SH and SH-L falls under high accuracy grade (no symbol).

Table2 Shaft Outer-diameter Tolerance

Type		LM Shaft	
Model No.	Accuracy	Normal clearance	Small gap
LM	High accuracy grade (no symbol)	f6, g6	h6
	Precision Grade (P)	f5, g5	h5
LME	—	h7	k6
LMF	High accuracy grade (no symbol)	f6, g6	h6
LMK			
LMH			
LM-L			
LMF-L			
LMK-L			
LMH-L			

Point of Design

Assembling the Linear Bushing

[Mounting the Nut]

Although the Linear Bushing does not require a large amount of strength for securing it in the axial direction, do not rely only on a press fit to support the nut. For the housing inner-diameter tolerance, see Table1 on A-542.

● Installing the Standard Type

Fig.1 and Fig.2 show examples of installing the standard type Linear Bushing. When securing the Linear Bushing, use snap rings or stopper plates.

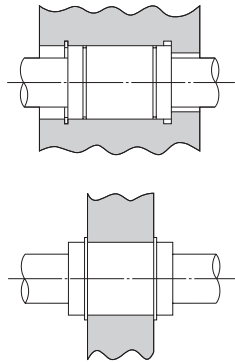

Fig.1 Snap Ring

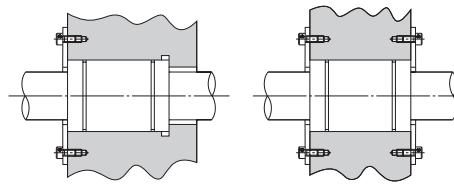

Fig.2 Stopper Plate

Linear Bushing

■Snap Ring for Installation

To secure Linear Bushing model LM, snap rings indicated in Table3 are available.

Note1) For models indicated with parentheses, use C-shape concentric snap rings.
 Note2) The Table3 commonly applies to models LM, LM-GA, LM-MG and LM-L.

Table3 Types of Snap Rings

Model No.	Snap ring			
	For outer surface		For inner surface	
	Needle snap ring	C-shape snap ring	Needle snap ring	C-shape snap ring
LM 3	—	—	AR 7	—
LM 4	—	—	8	—
LM 5	WR 10	10	10	10
LM 6	12	12	12	12
LM 8	—	15	15	15
LM 8S	—	15	15	15
LM 10	19	19	19	19
LM 12	21	21	21	21
LM 13	23	22	23	—
LM 16	28	—	28	28
LM 20	32	—	32	32
LM 25	40	40	40	40
LM 30	45	45	45	45
LM 35	52	52	52	52
LM 38	—	56·58	57	—
LM 40	—	60	60	60
LM 50	—	80	80	80
LM 60	—	90	90	90
LM 80A	—	120	120	120
LM 100A	—	(150)	150	—
LM 120A	—	(180)	180	—

■Set Screws Not Allowed

Securing the nut by pressing the outer surface with one set screw as shown in Fig.3 will cause the nut to be deformed.

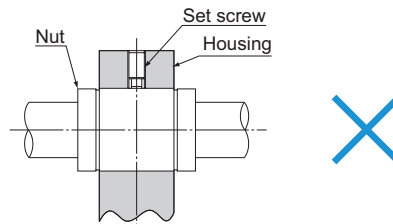
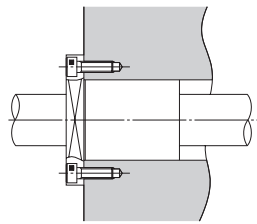

Fig.3

Point of Design
Assembling the Linear Bushing

● **Installing a Flanged Type**

With models LMF, LMK and LMH, the nut is integrated with a flange. Therefore, the Linear Bushing can be mounted only via the flange.



Nut mounted via socket and spigot joint

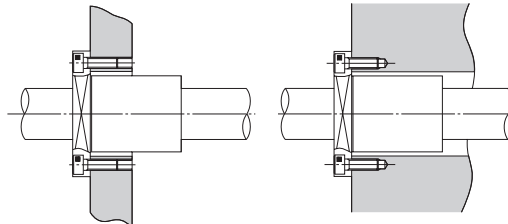

Mounted via a flange only

● **Installing a Clearance-adjustable Type**

To adjust the clearance of a clearance-adjustable type (-AJ), use a housing that allows adjustment of the nut outer diameter so as to facilitate the adjustment of the clearance between the Linear Bushing and the LM shaft. Positioning the slit of the Linear Bushing at an angle of 90° with the housing's slit will provide uniform deformation in the circumferential direction. (See Fig.4.)

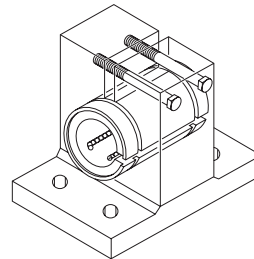

Fig.4

● **Mounting an Open Type**

For an open type (-OP), also use a housing that allows adjustment of the nut outer diameter as shown in Fig.5.

Open types are normally used with a light preload. Be sure not to give an excessive preload.

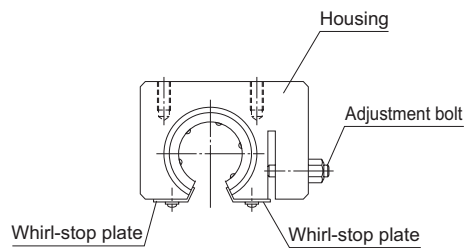
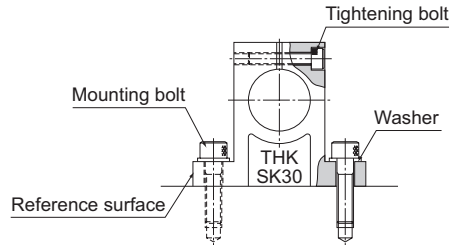

Fig.5

Linear Bushing

[Mounting the Shaft End Support]

Shaft end support model SK can easily be secured to the table using mounting bolts. Model SK enables the LM shaft to firmly be secured using tightening bolts.



[Installing an LM Case Unit]

● **Attaching Model SC (SL)**

Since models SC and SL can be attached from the top or bottom by simply tightening it using bolts, the installation time can be shortened. (See Fig.6.)

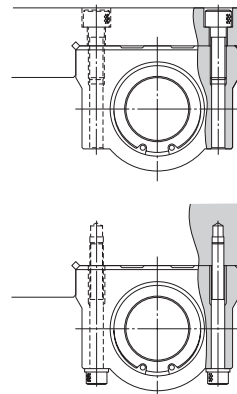

Fig.6

● **Attaching Model SH (SH-L)**

Since models SH and SH-L can be attached from the top or bottom by simply tightening it using bolts, the installation time can be shortened. (See Fig.7.)

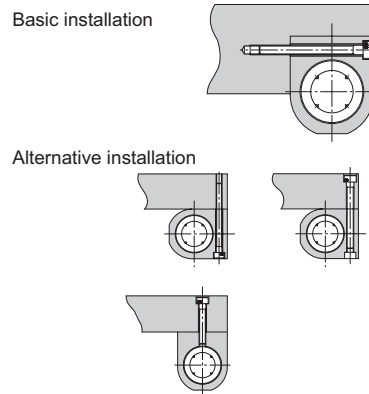

Fig.7

Point of Design
Assembling the Linear Bushing

[Incorporating the Nut]

When incorporating the standard Linear Bushing into a housing, use a jig and drive in the nut, or use a flatter plate and gently hit the nut, instead of directly hitting the side plate or the seal. (See Fig.8.)

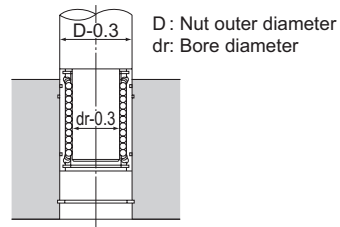

Fig.8

[Inserting the LM Shaft]

When inserting the LM shaft into the Linear Bushing, align the center of the shaft with that of the nut and gently insert the shaft straightforward into the nut. If the shaft is slanted while it is inserted, balls may fall off or the retainer may be deformed. (See Fig.9.)

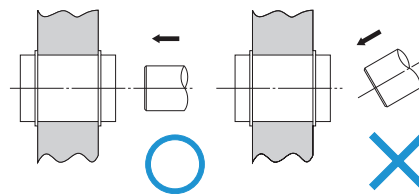

Fig.9

[When Under a Moment Load]

When using the Linear Bushing, make sure the load is evenly distributed on the whole ball raceway. In particular, if a moment load is applied, use two or more Linear Bushing units on the same LM shaft and secure an adequately large distance between the units.

If using the Linear Bushing under a moment load, also calculate the equivalent radial load and identify the correct model number. (See A-538.)

[Rotational Use Not Allowed]

The Linear Bushing is not suitable for rotational use for a structural reason. (See Fig.10.)

Forcibly rotating it may cause an unexpected accident.

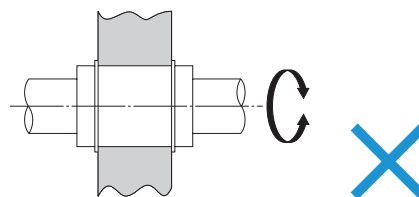

Fig.10

[Precautions on Installing an Open Three-ball-row Type Linear Bushing]

When installing an open three-ball-row type Linear Bushing, mount it while taking into account the load distribution as indicated in Fig.11.

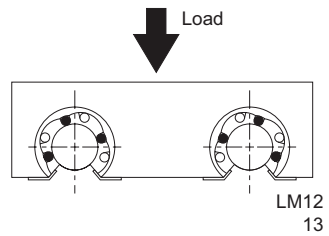

Fig.11

[Attaching Felt Seal Model FLM]

The felt seal can be press-fit into a housing finished to H7, but cannot be used as a stopper for preventing the Linear Bushing from coming off. Be sure to use the felt seal by attaching it as indicated in the Fig.12.

Also make sure to impregnate the felt with sufficient lubricant before attaching it.

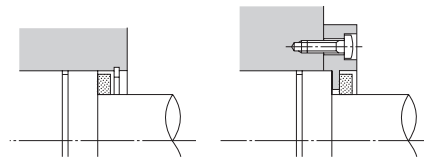

Fig.12

Lubrication

The Linear Bushing requires grease or oil as a lubricant for its operation.

[Grease Lubrication]

When installing a type attached with seals on both sides (···UU) to the LM shaft, apply grease to rows of balls in the Linear Bushing.

When installing standard types (without seal), perform the same as above or apply grease to the LM shaft.

Afterward, replenish grease of the same type as necessary according to the service conditions. We recommend using high-quality lithium-soap group grease No. 2.

[Oil Lubrication]

Turbine oil, machine oil and spindle oil are commonly used as a lubricant.

When oiling the Linear Bushing, drop oil on the LM shaft, or infuse it from the greasing hole on the housing as shown in Fig.1.

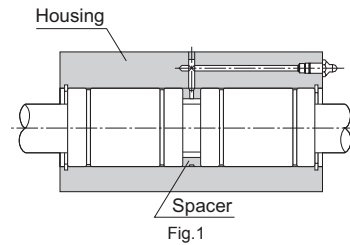

Material and Surface Treatment

For the Linear Bushing and the LM shaft, highly corrosion-resistant stainless steel types are available for some models.

Although the LM shaft can be surface treated, some types may not be suitable for the treatment. Contact THK for details.

Contamination Protection

Entrance of dust or other foreign material into the Linear Bushing will cause abnormal wear or shorten the service life. When nut contamination is expected, it is important to select an effective sealing device or dust-control device that meets the environment conditions.

For the Linear Bushing, a special synthetic rubber seal that is highly resistant to wear and a felt seal (highly dust preventive with low seal resistance) are available as contamination protection accessories.

In addition, THK produces round bellows. Contact us for details.

Felt Seal Model FLM

● For detailed dimensions, see B-461.

Linear Bushing model LM series include types equipped with a special synthetic rubber seal (LM...UU, U). If desiring to have an additional contamination protection measure, or desiring to lower the seal resistance, use the felt seal model FLM.

[Handling]

- (1) Disassembling components may cause dust to enter the system or degrade mounting accuracy of parts. Do not disassemble the product.
- (2) Dropping or hitting the Linear Bushing may damage it. Giving an impact force to the bushing could also cause damage even if the product looks intact.

[Lubrication]

- (1) Thoroughly remove anti-rust oil and feed lubricant before using the product.
- (2) Do not mix lubricants of different physical properties.
- (3) In locations exposed to constant vibrations or in special environments such as clean rooms, vacuum and low/high temperature, normal lubricants may not be used. Contact THK for details.
- (4) When planning to use a special lubricant, contact THK before using it.

[Precautions on Use]

- (1) Entrance of foreign material may cause damage to the ball circulating component or functional loss. Prevent foreign material, such as dust or cutting chips, from entering the system.
- (2) Do not use the product at temperature of 80 °C or higher. Contact THK if you desire to use the product at a temperature of 80°C or higher.
- (3) Please be careful when using the product in an environment with excessive coolant. The coolant may cause premature failure if it penetrates the bushing nut. Contact THK for further details.
- (4) If foreign material adheres to the product, replenish the lubricant after cleaning the product.
- (5) When using the product in locations exposed to constant vibrations or in special environments such as clean rooms, vacuum and low/high temperature, contact THK in advance.

[Storage]

When storing the Linear Bushing, enclose it in a package designated by THK and store it while avoiding high temperature, low temperature and high humidity.

